

Klappen

Bodensaugkasten mit Klappe

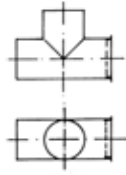

Spiessen-
abscheider
verzinkt
mit Deckel



Rückschlagklappen verzinkt

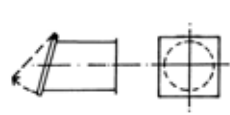

Rohrrückschlagklappen verzinkt

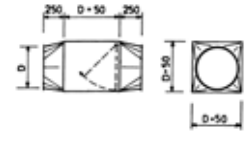

Ø mm	Preis	Preis	Preis	Preis
80		80.00	46.00	
100	176.10	82.00	48.00	
120	183.20	82.00	52.00	
125	183.20	90.00	52.00	
140	183.20	94.00	56.00	
150	186.30	94.00	62.00	571.00
160	187.15	98.00	62.00	571.00
180	193.10	106.00	72.00	581.00
200	198.40	120.00	88.00	581.00
225			90.00	584.00
250			96.00	694.00
275			116.00	694.00
300			130.00	694.00
315			130.00	707.00
350			158.00	707.00
400			218.00	721.00
450			256.00	1190.00
500			286.00	1300.00
550			286.00	1367.00
600				1431.00

Montage-Material

Gewindestange
M 8/M 10



Gewinderohr 1/2"



Grundplatte 1/2"

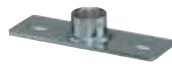

Gewindehülsen
M 8/M 10



Langmuttern
sechskant, verzinkt
M8/25 mm



Stockschrauben
verzinkt M 8/M 10



Länge mm	Preis	Länge mm	Masse mm	Preis	Preis	Länge mm	Preis	Länge mm	Preis
1000	2.50	2000	120 x 40 x 4	2.60	2.30	25	1.10	60	2.90
2000	5.00							80	3.30
								100	4.50

Winkel 40 x 40 mm

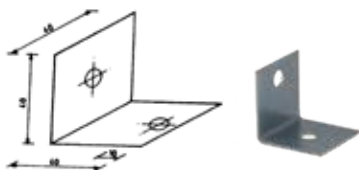

Winkel 40 x 200 mm

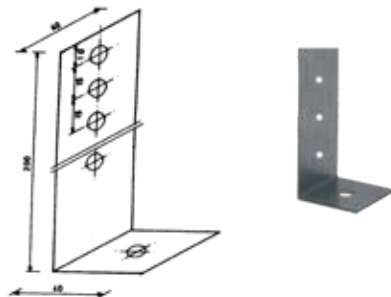

Winkel 40 x 960 mm

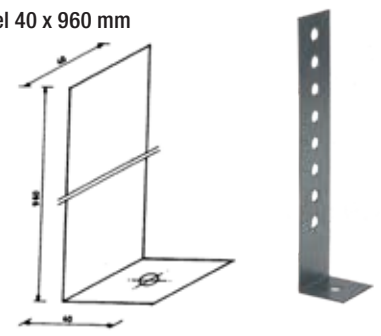

Preis	Preis	Preis
4.80	17.20	20.00

Alle Befestigungswinkel sind besonders geeignet für die direkte Befestigung mit Sickenhellen

Eine andere Anfrage, kontaktieren Sie uns!

Wandwinkel

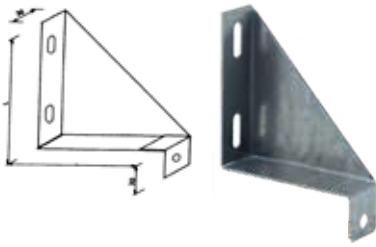

Rohrschellen

mit M8/M10/1/2" Anschlussgewinde und Zellgummi-Einlage
Breite 30 mm



Rohrschellen

1/2" verstärkte Ausführung
Breite bis Ø 180 mm 30 mm
ab Ø 200 mm 40 mm



Ø	Preis	Ø mm	Preis	Ø mm	Preis
30 x 100	14.40	80	7.90	80	14.00
30 x 140	16.80	100	8.50	100	16.30
30 x 180	19.00	120	9.90	120	18.50
30 x 200	21.40	125	9.90	125	19.10
30 x 220	23.80	140	11.60	140	21.60
		150	12.90	150	22.10
		160	12.90	160	23.00
		180	13.20	180	25.20
		200	15.50	200	25.20
		225	17.90	225	26.10
		250	19.70	250	27.30
		275/280	21.50	275/280	33.10
		300	22.90	300	35.80
		315	23.80	315	38.20
		350	25.50	350	40.80
		400	27.80	400	45.70
		450	31.50	450	50.70
		500	36.90	500	55.70

Zyklon

Zyklone Typ JA

links oder rechts



Typ	Preis Zyklone	Zubehör			
		Flacheisen- Gegenrahmen	Füsse für Zyklon freie Höhe 1,0 m	Staubbehälter mit Konus und Flex-Verbindung	Eingang von rechteckig auf rund
JA-20	1270.00	27.00	870.00	390.00	110.00
JA-35	1450.00	29.00	1030.00	395.00	120.00
JA-50	1680.00	31.00	1030.00	395.00	150.00
JA-65	2505.00	41.00	1115.00	405.00	190.00
JA-100	4725.00	49.10	1225.00	445.00	215.00
JA-130	8105.00	72.10	2260.00	445.00	470.00
JA-160	9885.00	127.50	2420.00	455.00	480.00
JA-180	11'850.00	133.00	2715.00		495.00

Rohrschalldämpfer

Rohrschalldämpfer verzinkt

ohne Einsatz



mit Einsatz



Rohr-Ø mm	Ø mit Isolation 100 mm	0,5 m – Preis	1,0 m – Preis	2,0 m – Preis	1,0 m – Preis	2,0 m – Preis
100	300	341.30	375.70			
120	320	346.15	387.25			
125	325	346.15	387.25			
140	340	354.40	404.30			
150	350	354.40	404.30	610.75		
160	360	355.90	406.15	613.45		
180	380	359.25	409.50	618.65		
200	400	361.40	422.25	626.55		
225	425	366.85	432.95	643.00	733.40	974.25
250	450	372.65	440.25	655.80	744.40	990.40
275	475	400.35	472.20	695.95	777.25	
300	500	406.45	483.45	714.55	790.65	1035.45
315	515	409.80	487.75	723.70	795.20	1058.55
350	550	418.90	503.25	723.70	815.60	1101.20
400	600	430.50	522.75	783.95	839.05	1149.90
450	650	510.55	611.95	885.05	965.70	1289.05
500	700	524.55	638.75	913.35	997.40	1328.00
550	750	561.10	681.95	973.35	1044.55	1395.60
600	800	596.10	746.50	1088.40	1051.90	1434.85

Rohrschalldämpfer verzinkt mit gelochtem Blech (perforiert)

ohne Einsatz



mit Einsatz



Rohr-Ø mm	Ø mit Isolation 100 mm	0,5 m – Preis	1,0 m – Preis	2,0 m – Preis	0,5 m – Preis	1,0 m – Preis	2,0 m – Preis
100	300	416.50	464.90				
120	320	421.05	475.25				
125	325	421.05	475.25				
140	340	430.80	493.80				
150	350	430.80	493.80				
160	360	433.25	496.55				
180	380	435.95	502.35	778.80			
200	400	440.55	517.25	793.70			
225	425	448.45	530.35	818.95	741.95	845.15	1181.25
250	450	453.95	542.85	839.05	751.40	863.40	1213.55
275	475	483.45	578.75	886.85	784.55	902.70	1268.65
300	500	491.10	593.35	913.95	793.10	921.55	1304.25
315	515	494.45	598.55	931.60	797.35	929.80	1328.00
350	550	504.45	619.55	965.40	811.05	955.35	1374.00
400	600	520.60	645.75	1017.15	832.05	990.70	1447.05
450	650	602.80	742.25	1135.60	951.40	1127.40	1611.45
500	700	620.45	774.85	1179.15	973.35	1169.10	1671.45
550	750	658.85	826.30	1255.55	1016.55	1227.85	1756.70
600	800	698.70	896.30		1060.70	1305.50	1912.25

Eine andere Anfrage, kontaktieren Sie uns!